

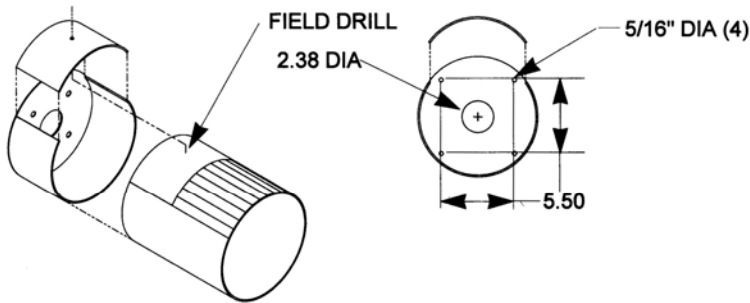

FORUM

9" ROUND

MOUNTINGS / ACCESSORIES



Wall mounted - Span

Fixture ends terminate in a cylindrical sleeve mounted to wall. Fixtures are adjustable plus or minus 1" within sleeves. Top locking cap assures permanent fixture location. Feed end is attached to recessed outlet box.

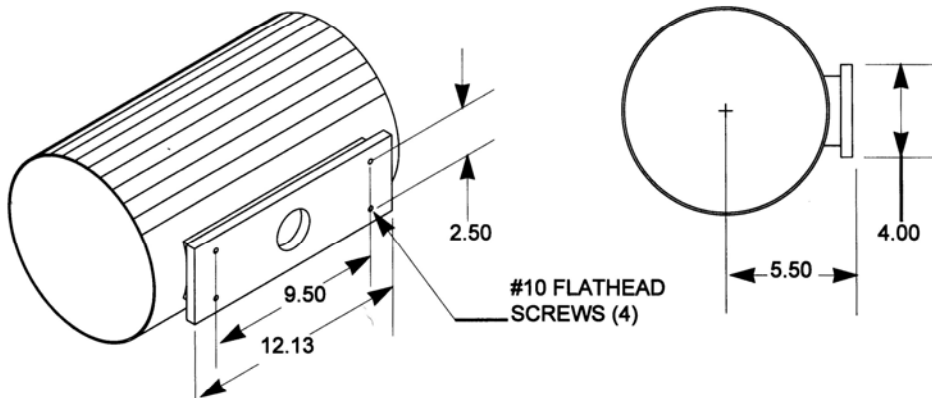

Edge Mounted

The fixture is cantilevered from the wall by means of an aluminum bracket system, for a distance of 4 1/2" from the wall to the centerline of the fixture. All brackets are drilled for support and feed as required.

NOTE: Centerline of R9AD fixture is 11/16" **BELOW** centerline of wall bracket.

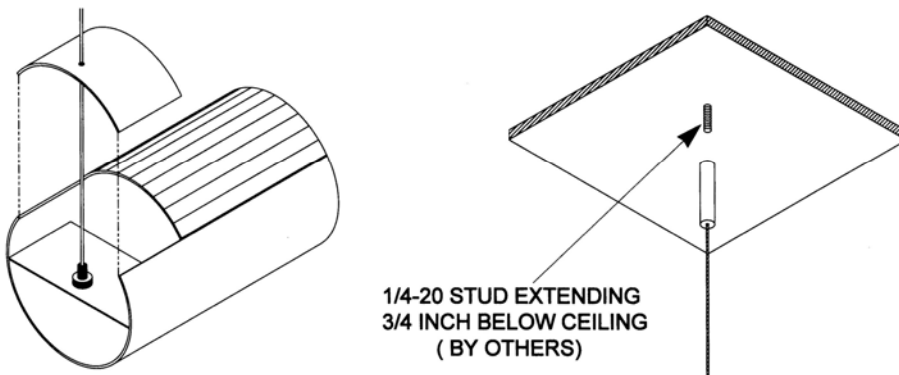

Cable Support

Cable can be used in place of stems to give the fixture a floating effect. The Forum hanging system is adjustable at the fixture. One fingertip push of the release pin and the cable gripper moves easily and exactly to the desired position. When used at a feed location, a coil cord (standard) or straight cord is required (black standard). For surface mounting, the contractor must install a 1/4" x 20 stud, extending 3/4" below the ceiling.

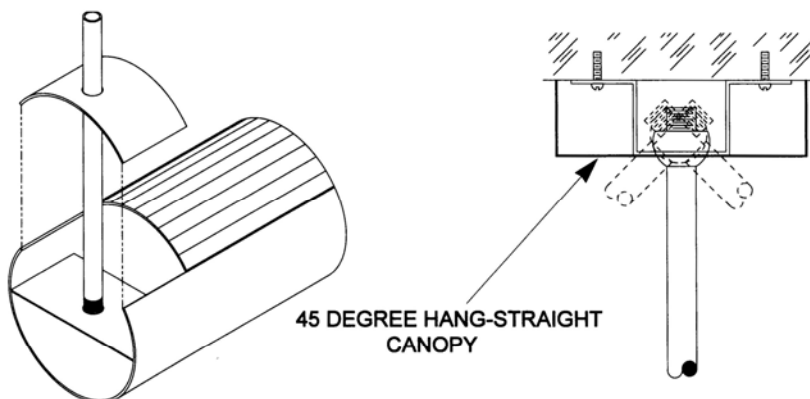

Stem Support

Standard stem length is 18" and has a plus or minus 1/2" adjustment. A round canopy and 45 degree swivel hanger are also standard. All mounting hardware is included.