



FORUM

Forecast 4

JOB _____

TYPE _____



RECESSED/
DIRECT

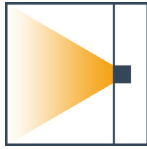

IN-WALL/
HORIZONTAL



IN-WALL/
VERTICAL



The Forecast series by FORUM is a line of hybrid steel housing/ aluminum trim rectilinear recessed luminaires.

Forecast 4 is a 4" wide housing with a 3 1/2" aperture. Multiple ceiling configurations are available including various grid ceiling types as well as overlap and flange free sheetrock.

Forecast 4 can be lamped with T5 and T8 lamps as well as LED.



ORDERING CODE

SRT- 44 - [] - [] - [] × [] - [] - [] - [] - []

Series	Trim	Lamping	Shielding	Length	Voltage	Finish	Option 1	Option 2
Forecast4 - 4"x4" recessed steel/ aluminum hybrid	FG = 9/16" grid TG = 15/16" grid BG = slot grid F = 1/2" flange FF = flange-free sheetrock	1T5 = 1T5 1T5S = 1T5 STAG 1T5H = 1T5 HO 1T5HS = 1T5 HO STAG 2T5 = 2T5 2T5S = 2T5 STAG 2T5H = 2T5 HO 2T5HS = 2T5 HO STAG 1T8 = 1T8 1T8S = 1T8 STAG 2T8 = 2T8 2T8S = 2T8 STAG	SAT = Satin lens WOL = White Opal lens PB = Parabolic Baffle SPB = Specular Parabolic Baffle WPB = White Parabolic Baffle WP = White Opal over Parabolic Baffle SAP = Satin Lens over Parabolic Baffle	2 = 2' 3 = 3' 4 = 4' 5 = 5' 6 = 6' 7 = 7' 8 = 8' XX = Specify run length in even foot increments	120V 277V UNV = Universal	WH = White AZ = Anodized Silver CC = Custom Color *	EC = Emergency Circuit EM1 = 550 Lumen battery pk EM2 = 1100 Lumen battery pk DIM = Dimming ** F = Fusing ASY = Asymmetric Reflector SW = Separate Switch OC = Occupancy Sensor MR = 37W MR16 Module *** P = Perimeter Mounting	

* Please provide custom color RAL # _____

** Please specify dimming manufacturer/model (if required) _____

*** Number of units 6" on center (Beginning of fixture)/(End of fixture) [] / []

TECHNICAL DRAWINGS

* Dimensions provided as general information. Please see shop drawings for specific rough in dimension

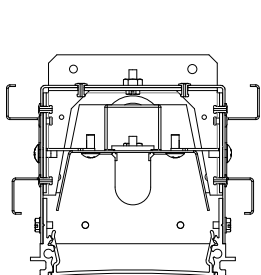

BG - Bolt Slot Grid

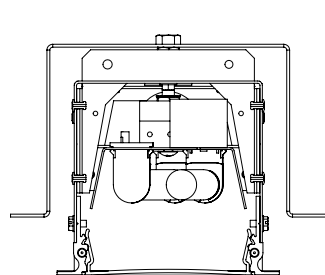

F - Overlap Flange
(drywall, wood, metal applications)

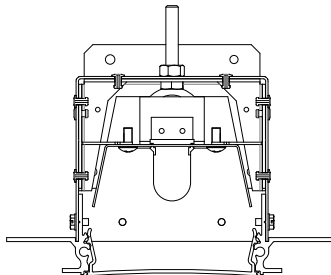

FF - Flange Free
(seamless drywall application)

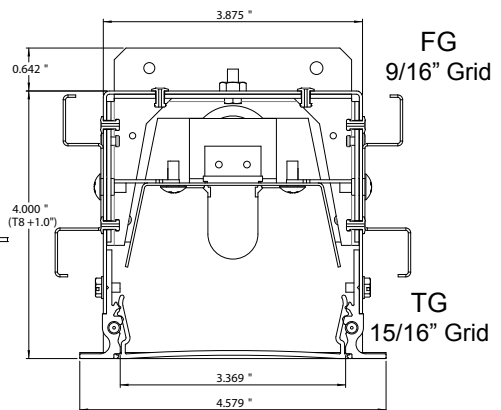

SPECIFICATION

* Forum reserves the right to change this information at any time

HOUSING: 18 GA cold rolled steel in a pre-paint white finish. Built in individual pieces up to 8 ft in length. Sections can be joined to form continuous runs.

GEARTRAY / REFLECTOR: Integrated geartray and reflector made from 20 GA cold rolled steel in a pre-paint white finish. Fully wired unit remains completely accessible from below via ballast panel.

TRIM/FLANGE: Extruded Aluminum trim is run around all 4 sides of the fixture body. Provides a clean and precise finish and is available for a number of ceiling applications.

SHIELDING: Satin frosted and white opal lenses are snap in. Parabolic baffles are made from high quality aluminum and come in a variety of finishes.

BALLAST: Electronic, high power factor, low THD, ballast used. 120V, 277V, and Universal Voltage available standard. Please consult factory for special ballast requirements.

LISTING: All fixtures bare an AFL-CIO/IBEW union label and are UL listed for recessed dry location. For alternative location configurations, please consult factory.