

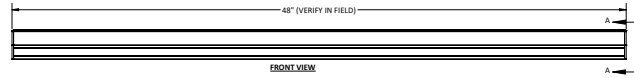

## RIZER DRAWINGS

### riZer Straight - EX. RIZUD-23-38-40-38-B-SIL-8-R0-A0-UNV-BZ-D10V

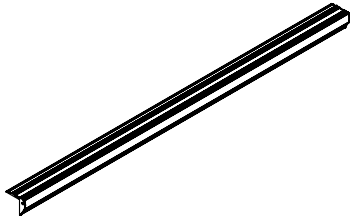

### riZer Curved - EX. RIZUD-23-38-40-38-B-SIL-8-R36-A90-UNV-BZ-D10V

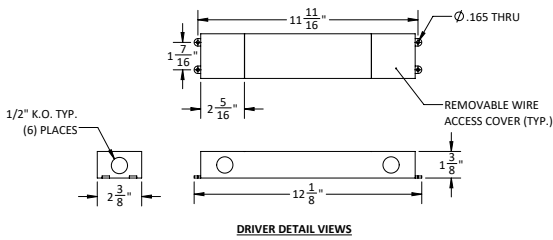
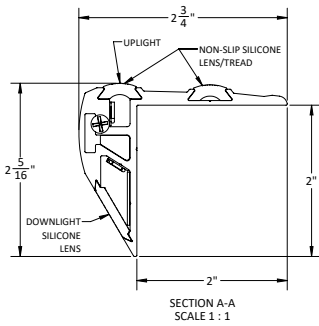
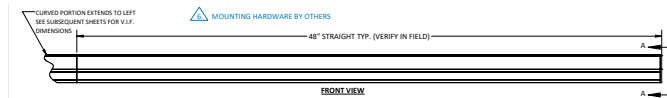
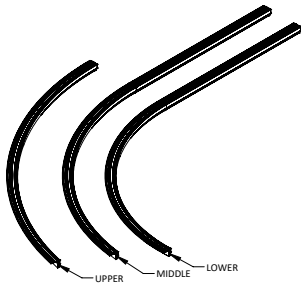

Customer Name	Date
Project Name	
Catalog Number	

## ***Pattern Worksheet***

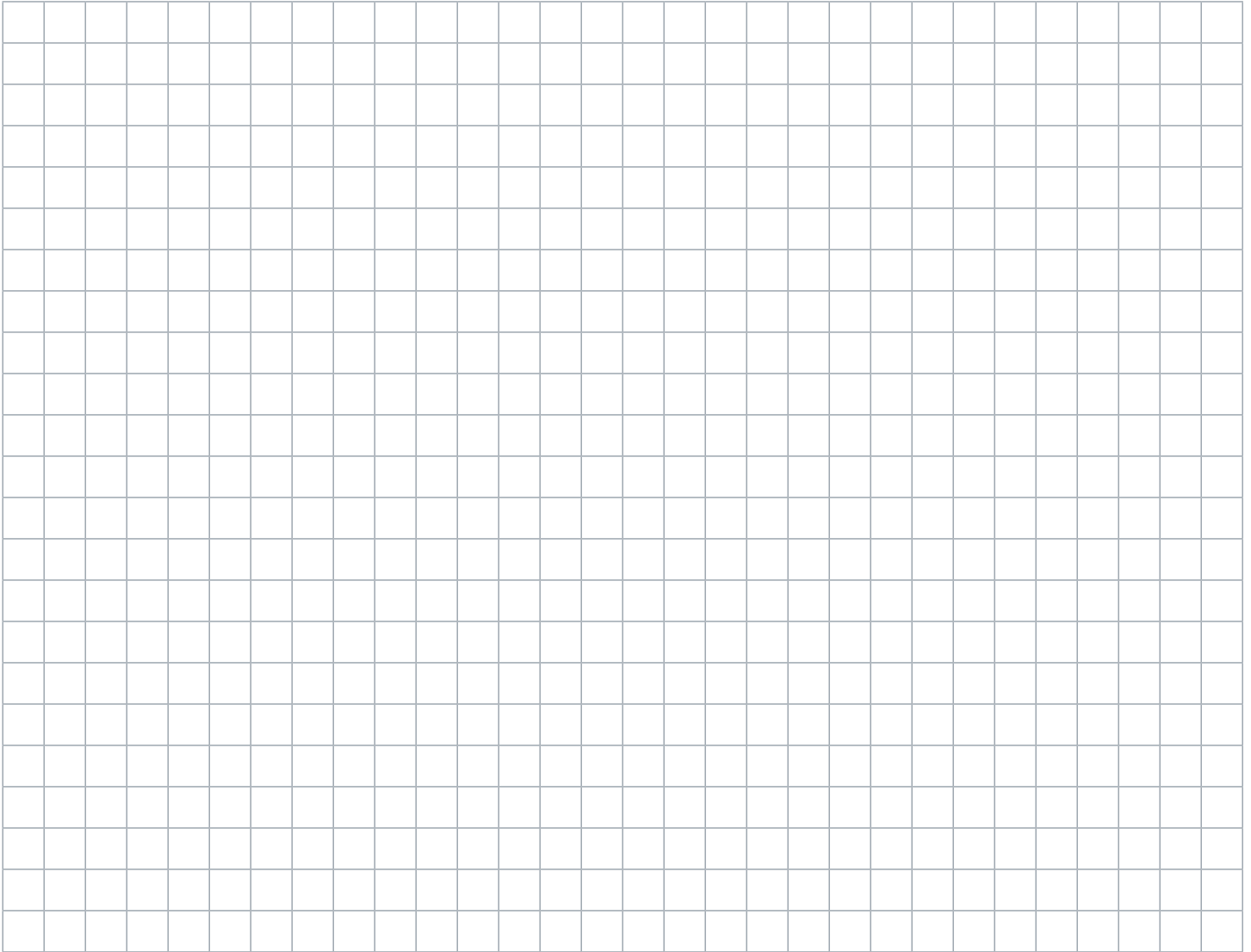

### CONSTRUCTION

<b>Housing:</b>	Extruded aluminum, machined endcaps
<b>Lens:</b>	Silicone lenses
<b>Paint:</b>	Anodized Black, Consult factory for other colors
<b>Weight:</b>	~1.3lb/ft

### OPTICAL SYSTEM

<b>Lumens:</b>	381 lm/ft
<b>Distribution:</b>	Up, Down, and Up/Down available
<b>Wattage:</b>	3.8 watts/ft
<b>CCT:</b>	2700k, 3000K, 3500K, 4000K, 5000K
<b>CRI (Min):</b>	TriGain® 90CRI
<b>R9 (Min):</b>	65
<b>Color Consistency:</b>	2SDCM

### ELECTRICAL

<b>Input Voltage:</b>	347V, Universal Voltage
<b>Input Frequency:</b>	50/60Hz
<b>Power Factor (PF):</b>	>0.9
<b>Total Harmonic Distortion (THD):</b>	<16% - 120V <20% - 277V
<b>Temperature / Humidity:</b>	Suitable for Damp Locations
<b>Transient Protection:</b>	All Non-Lutron = 2.5KV Lutron = 4KV

### CONTROLS

<b>Dimming:</b>	0-10V 1% power class; Lutron Hi-lume 1% 2-wire LED driver; Digitally Addressable Lighting Interface; DMX; Daintree Wireless Controls for zonal control
-----------------	--------------------------------------------------------------------------------------------------------------------------------------------------------

### OPERATING TEMPERATURE

Product	Operating Temperature
<b>RIZ:</b>	25°C

### LUMEN MAINTENANCE

- L70>50K Hours

### MOUNTING

- Surface mount directly to stair edge
- Interior use only

### DESIGN LIFE & WARRANTY

- Warranty:**
- LED boards - 5 years
  - LED drivers (standard) - 5 years
  - LED drivers (Lutron) - 3 years